

ROBESLEE

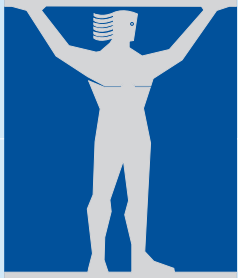

CONCRETE

T-BEAM FLOORS

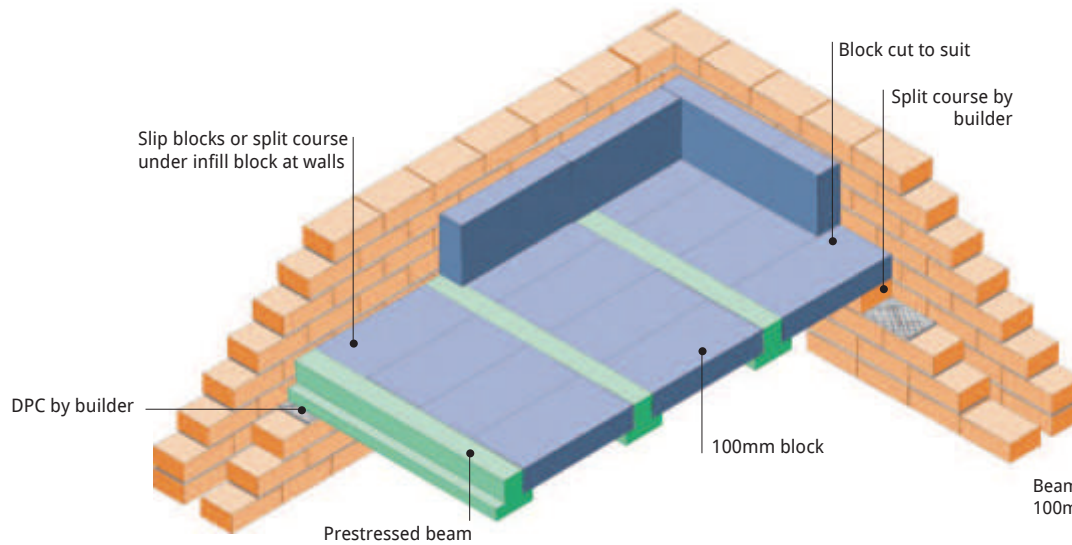

The T42 Floor Beam combines concrete beams and infill blocks to provide a highly effective and easy to install flooring system

The T42 Beam is nominally 155 deep and weighs 40kg/ m. It is manufactured using concrete with a strength of 50 N/mm².

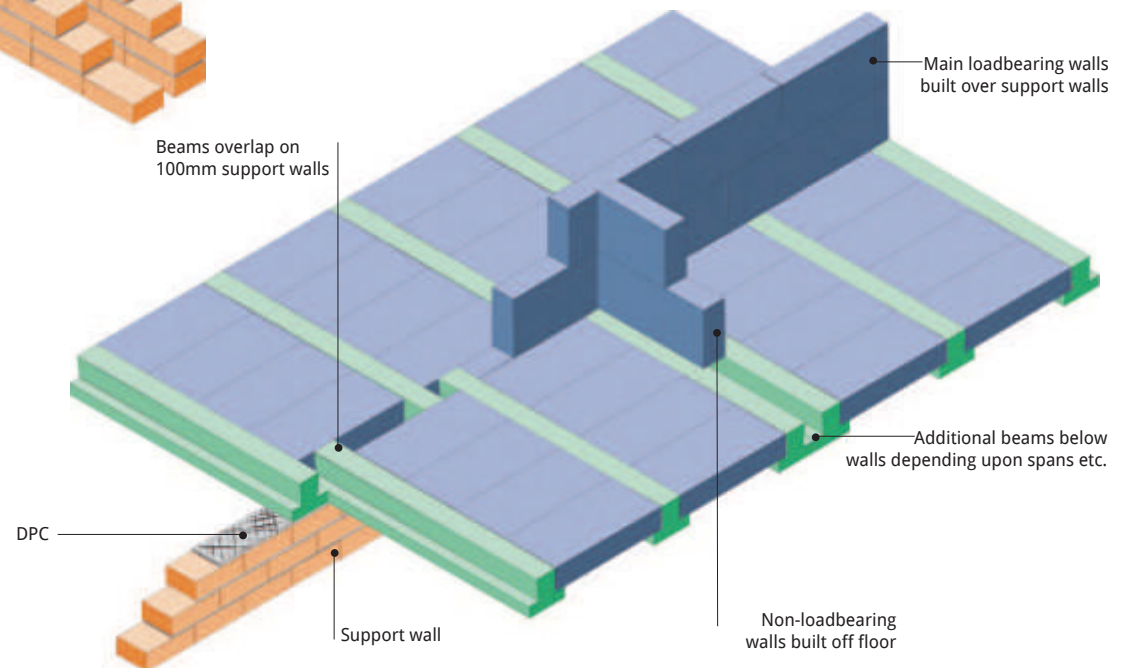

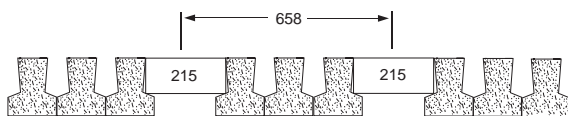
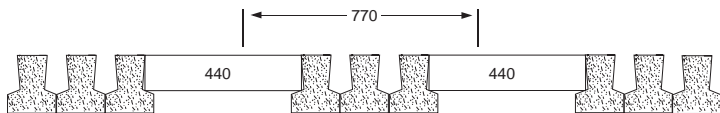
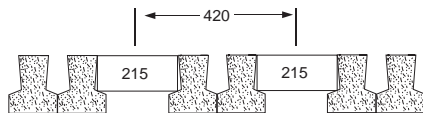
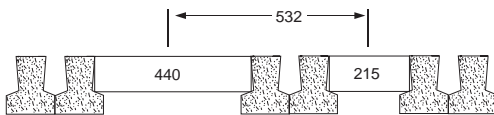
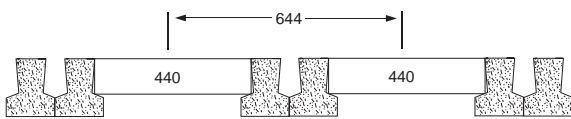
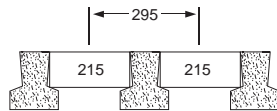
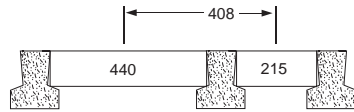
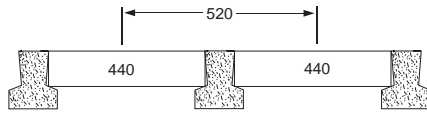

T-BEAM FLOORS

STANDARD CENTRES	SECTIONS	Maximum Spans (m) for imposed load kN/m ²					
		1.5	2.0	2.5	3.0	5.0	7.0
SINGLE 520 (1.8kN/m ²)		4.40	4.10	3.90	3.80	3.20	2.80
SINGLE 408 (1.9kN/m ²)		4.90	4.60	4.40	4.20	3.60	3.20
SINGLE 295 (2.2kN/m ²)		5.60	5.30	5.10	4.90	4.20	3.80
DOUBLE 644 (2.2kN/m ²)		5.40	5.10	4.90	4.70	4.10	3.60
DOUBLE 532 (2.4kN/m ²)		5.80	5.60	5.30	5.10	4.40	4.00
DOUBLE 420 (2.7kN/m ²)		6.00	6.00	5.90	5.60	4.90	4.40
TREBLE 770 (2.5kN/m ²)		5.90	5.60	5.40	5.20	4.50	4.00
TREBLE 658 (3.0kN/m ²)		6.00	6.00	5.80	5.50	4.80	4.30

Robeslee T-Beam Floors

The diagram below is a cross section taken from the T42 Floor Beam. An allowance of 1.20 k.N/m² for finishes has been made when calculating the table.

The table above shows maximum clear spans in metres for the Robeslee T42 Floor Beam (125x155) under uniformly distributed live loads using 1350 kg/m³ solid block.

← Closer look at the sections of the T42 Floor Beam

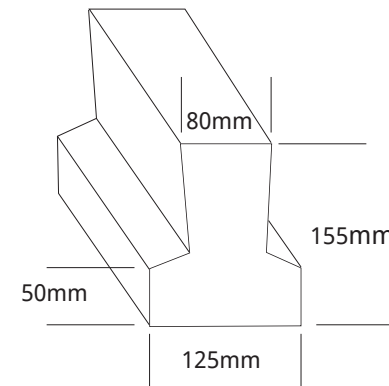

The T42 Floor beam has been designed using our "STAR" technology system (in accordance with BS 5977 Part 1: 1981 and Part 2: 1983 and BS 8110 Part 1: 1985 and Part 2: 1985) and is manufactured using an advanced extrusion method at our factory in Kirkintilloch

The T42 Floor Beam can be made to any required length up to 6 metres within given limits.

Robeslee offer a free technical and computer aided design service
telephone 0141 775 2677
to assist you in the use of the T42 Floor Beam.

The service provides comprehensive details of floor layouts, working drawings and quantity requirements.



T-BEAM FLOORS _ Technical Information

The T42 Floor Beam, combines concrete beams and infill blocks to provide a highly effective and easy to install flooring system. The T42 Beam is nominally 155 deep and weighs 40kg/ m. It is manufactured using concrete with a strength of 50 N/mm².

Infill Blocks

Infill blocks can be any standard building blocks (440x215x100) complying with BS6073:Part 1-1981. They must have a maximum density of 1350 kg/m³ and have 3.5 N/mm² - minimum strength. For increased sound resistance we recommend using blocks with a density of 1800 kg/m³.

Bearings

All beams should be placed perpendicular to the end support unless otherwise shown. Each beam requires a minimum end bearing of 100mm to each end when supported by brickwork/ blockwork and 75mm when supported by steelwork.

Grouting

A 3:1 sand:cement should be brushed into the joints between the beams and the blocks.

Floor Finishes

When laid the floor can take a wide variety of finishes. We would recommend the use of a sand:cement levelling screed before the application of final finishes. Garage floors require a 50mm concrete screed using a grade 25 concrete and suitable reinforcement.

Cut Blocks

All blocks are to be cut using suitable mechanical means to leave a clean, vertical square edged face.

Slip Blocks

Slip Blocks 440 x 100 x 40 (nominal) are used around the perimeter of the floor to make up the difference in level between the underside of the blocks.

Service Holes

Infill blocks may be omitted as necessary to accommodate services.

Air Vents

Void ventilators are required by the NHBC and the spacings may vary. Please consult vent manufacturers for details and supply.

Handling

Care should be taken to ensure all beams are lifted horizontally. Beams should not be lifted upside down or allowed to rotate while being handled.

Camber

As the beams are made from prestressed concrete they have slight upward camber. Due allowance must be made for this in determining finishes and overall floor thickness.